





Colisage: 6 m
 Poids net: 7.190 Kg
 Matière: FIL CLAIR Ø4.5 C9D CLASSE 1 - NF EN 16120-2
 FIL CLAIR Ø4.9 C9D CLASSE 1 - NF EN 16120-2
 Aptitude à la galvanisation: CLASSE 1 [Si(%) < 0.03 et Si(%) + 2.5 P(%) < 0.09]
 Revêtement: GAC - Galvanisation à chaud par immersion selon NF EN 1461
 Dimensionnel garanti avant galvanisation
 CPS: Charge pratique de sécurité - NF EN 61537
 33 daN/m : portée 1.5m
 22 daN/m : portée 2.0m
 15 daN/m : portée 2.5m

 	DESIGNATION:		CC 400 BFR30 GAC		
	Propriété GEWISS France - Toute reproduction et utilisation tierce requièrent l'accord écrit de GEWISS France				
Usine de Liernais BP 1 21430 LIERNAIS TEL.: 03.80.90.51.00 FAX: 03.80.84.43.66	DESSINE PAR:	BERGEROT D.	VERIFIE PAR:	LEGUY C.	FORMAT A4 H
	DATE:	09/07/2020	ECHELLE:	1:5	
	N°:	MV50226_02			

CODE	REF.	POIDS NET (Kg)	POIDS NET (Kg/m)	vx (mm)	vy (mm)	S (mm ²)	Ixx (mm ⁴)	Iyy (mm ⁴)	Ixx/vx (mm ³)	Iyy/vy (mm ³)	RAYON DE GIRATION R (mm)
MV50226	400 BFR30	7.190	2.397	24.535	208.4	190.852	37106.81	4176650.576	1512.4	20041.51	209.601

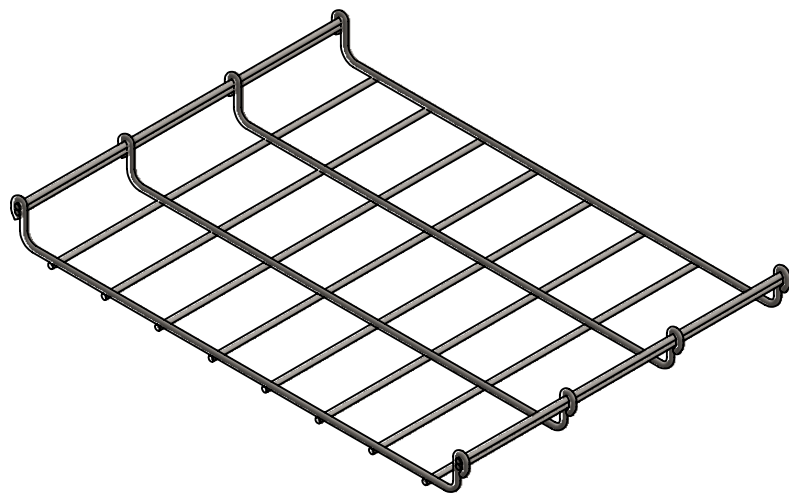
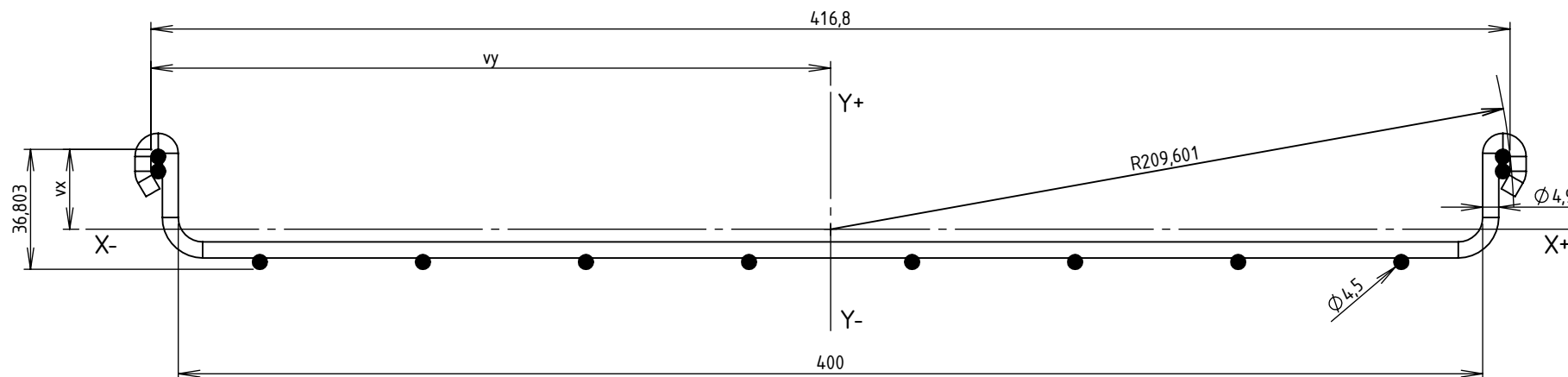

Matière: FIL CLAIR Ø4.5 C9D CLASSE 1 - NF EN 16120-2
 FIL CLAIR Ø4.9 C9D CLASSE 1 - NF EN 16120-2
 Aptitude à la galvanisation: CLASSE 1 (Si(%) < 0.03 et Si(%) + 2.5 P(%) < 0.09)
 Revêtement: GAC - Galvanisation à chaud par immersion selon NF EN 1461
 Dimensionnel garanti avant galvanisation

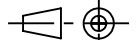
 Usine de Liernais BP 1 21430 LIERNAIS TEL.: 03.80.90.51.00 FAX: 03.80.84.43.66	DESIGNATION:		CC 400 BFR30 GAC INERTIE		
	Propriété GEWISS France - Toute reproduction et utilisation tierce requièrent l'accord écrit de GEWISS France				
	DESSINE PAR:	BERGEROT D.	VERIFIE PAR:	LEGUY C.	FORMAT A4 H
	DATE:	09/07/2020	ECHELLE:	1:2	
	N°:	MV50226_02			

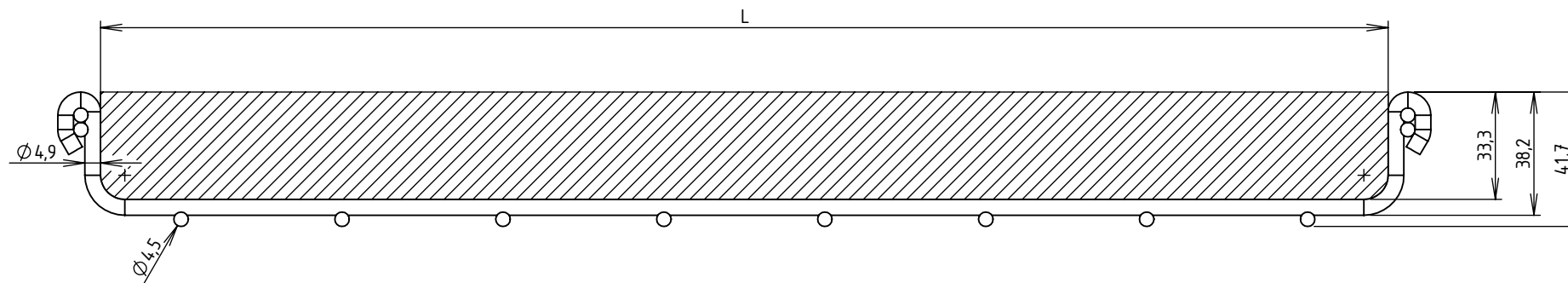

CODE	L (mm)	SECTION UTILE (mm ²)	CONTENANCE (Kg/m)	
			Communication (d = 0.15 Kg/cm ² /m)	Puissance (d = 0.25 Kg/cm ² /m)
MV50X26	400	13297	19.95	33.24



Usine de Liernais
BP 1
21430 LIERNAIS
TEL.: 03.80.90.51.00
FAX: 03.80.84.43.66

DESIGNATION:

SECTIONS UTILES ET CONTENANCES BFR30
CC 400 BFR30

Propriété GEWISS France - Toute reproduction et utilisation tierce requièrent l'accord écrit de GEWISS France

DESSINE PAR:	BERGEROT D.	VERIFIE PAR:	LEGUY C.	FORMAT A4 H
DATE:	05/06/2024	ECHELLE:	1:2	
N°:	MV50X26			