

Colisage: 12 m
 Poids net: 4.579 Kg
 Matière: FIL Ø3.7 C9D CRAPAL 4 - NF EN 10016-2
 Revêtement: ZA275 CLASSE A - NF EN 10244-2
 FIL Ø4.5 C9D CRAPAL 4 - NF EN 10016-2
 Revêtement: ZA280 CLASSE A - NF EN 10244-2
 CPS: Charge pratique de sécurité - NF EN 61537
 50 daN/m : portée 1.5m
 39 daN/m : portée 2.0m
 25 daN/m : portée 2.5m



Usine de Liernais
 BP 1
 21430 LIERNAIS
 TEL.: 03.80.90.51.00
 FAX: 03.80.84.43.66

DESIGNATION:

CC 150 BFR110 HP

Propriété GEWISS France - Toute reproduction et utilisation tierce requièrent l'accord écrit de GEWISS France

DESSINE PAR:	BERGEROT D.	VERIFIE PAR:	LEGUY C.	FORMAT A4 H
DATE:	17/07/2020	ECHELLE:	1:4	
N°:	MV50742_06			

CODE	REF.	POIDS NET (Kg)	POIDS NET (Kg/m)	vx (mm)	vy (mm)	S (mm ²)	Ixx (mm ⁴)	Iyy (mm ⁴)	Ixx/vx (mm ³)	Iyy/vy (mm ³)	RAYON DE GIRATION R (mm)
MV50742	150 BFR110	4.579	1.526	65.335	82.2	118.273	261343.368	581735.723	4000.05	7077.07	98.51

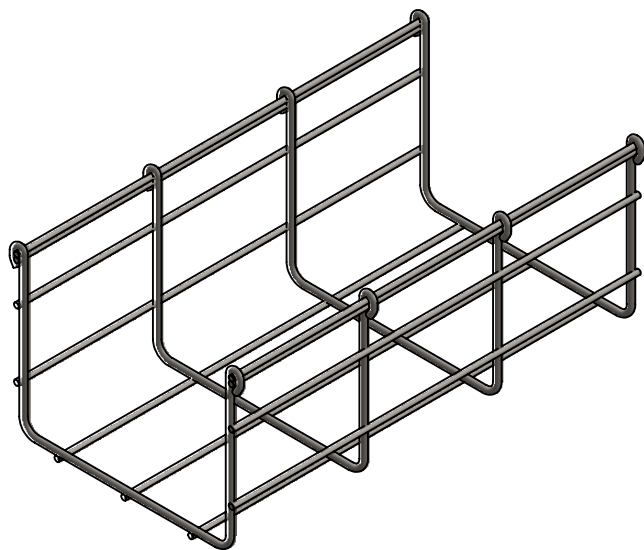
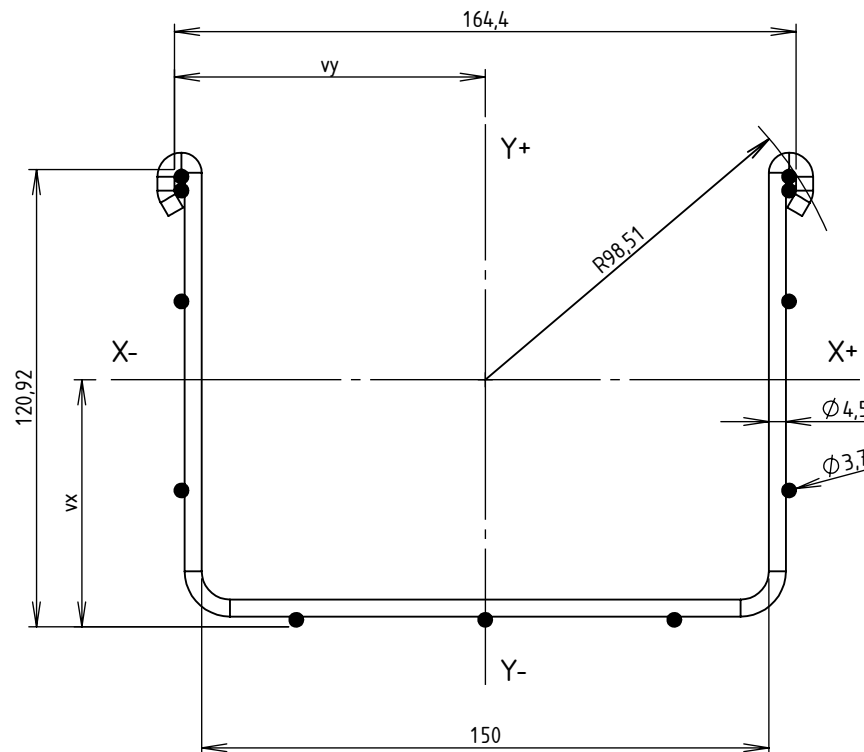

Matière: FIL Ø3.7 C9D CRAPAL 4 - NF EN 10016-2
 Revêtement: ZA275 CLASSE A - NF EN 10244-2
 FIL Ø4.5 C9D CRAPAL 4 - NF EN 10016-2
 Revêtement: ZA280 CLASSE A - NF EN 10244-2



Usine de Liernais
 BP 1
 21430 LIERNAIS
 TEL.: 03.80.90.51.00
 FAX: 03.80.84.43.66

DESIGNATION:

CC 150 BFR110 HP
 INERTIE

Propriété GEWISS France - Toute reproduction et utilisation tierce requièrent l'accord écrit de GEWISS France

DESSINE PAR:	BERGEROT D.	VERIFIE PAR:	LEGUY C.	FORMAT A4 H
DATE:	17/07/2020	ECHELLE:	1:2	
N°:	MV50742_06			

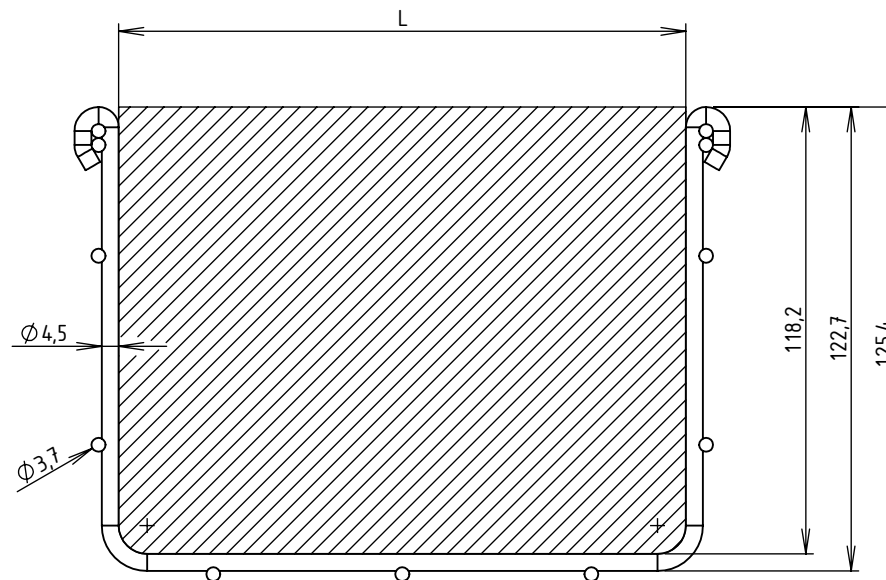

CODE	L (mm)	SECTION UTILE (mm ²)	CONTENANCE (Kg/m)	
			Communication (d = 0.15 Kg/cm ² /m)	Puissance (d = 0.25 Kg/cm ² /m)
MV50X42	150	17708	26.56	44.27



Usine de Liernais
BP 1
21430 LIERNAIS
TEL.: 03.80.90.51.00
FAX: 03.80.84.43.66

DESIGNATION:
SECTIONS UTILES ET CONTENANCES BFR110
150 BFR110

Propriété GEWISS France - Toute reproduction et utilisation tierce requièrent l'accord écrit de GEWISS France

DESSINE PAR:	BERGEROT D.	VERIFIE PAR:	LEGUY C.	FORMAT A4 H
DATE:	05/06/2024	ECHELLE:	1:2	
N°:	MV50X42			