

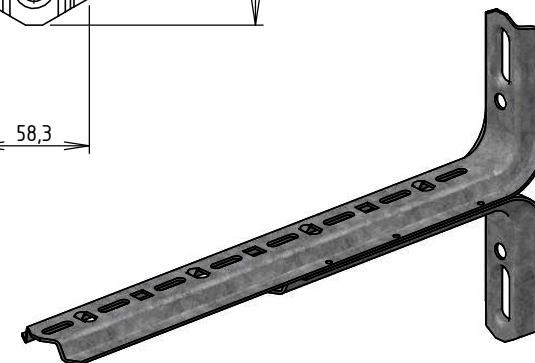

Surface : 117082 mm²
 Poids net : 0.883 Kg
 Colisage : 12 NR
 CPS : 130 daN
 Matière : BANDE REFENDUE 2.00 S250GD + Z275 - NF EN ISO 10143/10346
 Revêtement : Z275 - NF EN 10346



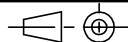
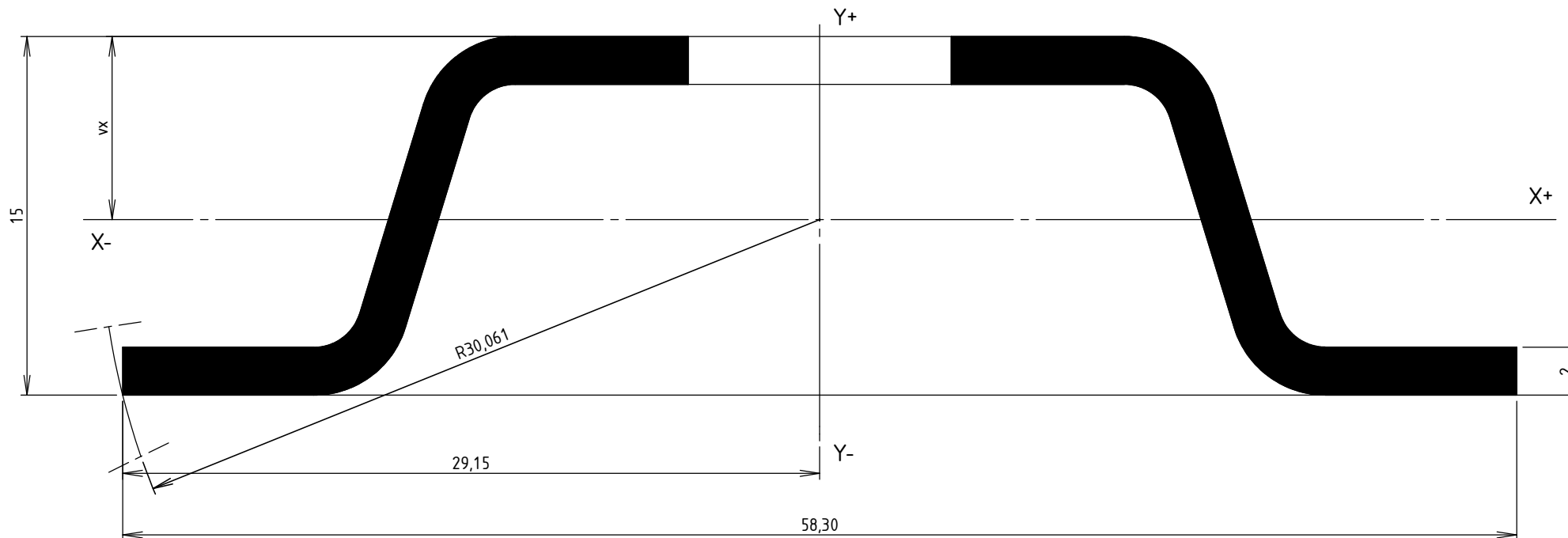

 	DESIGNATION:			FORMAT A4 H
	CONSOLE OMEGA LG410 RENF Z275			
Usine de Liernais BP 1 21430 LIERNAIS TEL.: 03.80.90.51.00 FAX: 03.80.84.43.66	PROPRIÉTÉ GEWISS FRANCE - Toute reproduction et utilisation tierce requièrent l'accord écrit de GEWISS FRANCE	DESSINE PAR: DOS SANTOS A.	VERIFIE PAR: LEGUY C.	N°:
	DATE: 05/03/2020	ECHELLE: 1:4	MV60113	
				

CODE	REF	POIDS NET (kg)	COLISAGE (NR)	CPS (daN)	vx (mm)	vy (mm)	S (mm ²)	Ixx (mm ⁴)	Iyy (mm ⁴)	Ivx/vx (mm ³)	Iyy/vy (mm ³)
MV60113	LG410	0.883	12	130	7.655	29.15	128.14	3884.73	42482.54	507.46	1457.37



Revêtement: Z275 - NF EN 10346

 	DESIGNATION:			CONSOLE OMEGA LG410 RENF Z275	
				INERTIES	
	Propriété GEWISS France - Toute reproduction et utilisation tierce requièrent l'accord écrit de GEWISS France				
	Usine de Liernais BP 1 21430 LIERNAIS TEL.: 03.80.90.51.00 FAX: 03.80.84.43.66	DESSINE PAR: DOS SANTOS A.	VERIFIE PAR: LEGUY C.	FORMAT A4 H	
	DATE: 05/03/2020	ECHELLE: 1:4			
	N°:	MV60113		