

Colisage: 6 m
 Poids net: 5.411 Kg
 Matière: FIL Ø3.7 INOX 304L - NF EN 10088
 FIL Ø4.5 INOX 304L - NF EN 10088
 CPS: Charge pratique de sécurité - NF EN 61537
 71 daN/m : portée 1.5m
 50 daN/m : portée 2.0m
 37 daN/m : portée 2.5m



Usine de Liernais
 BP 1
 21430 LIERNAIS
 TEL.: 03.80.90.51.00
 FAX: 03.80.84.43.66

DESIGNATION:

CC 200 BFR110 INOX 304L

Propriété GEWISS France - Toute reproduction et utilisation tierce requièrent l'accord écrit de GEWISS France

DESSINE PAR:	BERGEROT D.	VERIFIE PAR:	LEGUY C.	FORMAT A4 H
DATE:	17/07/2020	ECHELLE:	1:4	
N°:	MV50643_07			

CODE	REF.	POIDS NET (Kg)	POIDS NET (Kg/m)	vx (mm)	vy (mm)	S (mm ²)	Ixx (mm ⁴)	Iyy (mm ⁴)	Ixx/vx (mm ³)	Iyy/vy (mm ³)	RAYON DE GIRATION R (mm)
MV50643	200 BFR110	5.411	1.804	63.233	107.2	150.529	308072.045	1268012.314	4872.01	11828.47	121.081

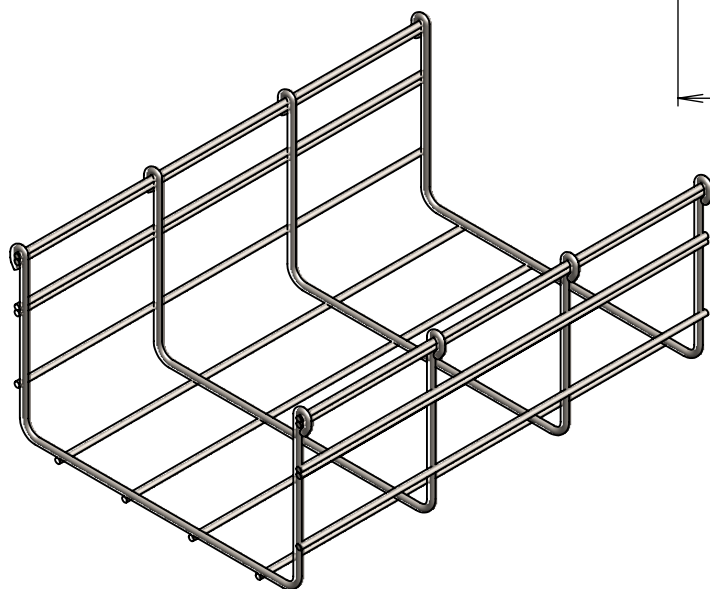
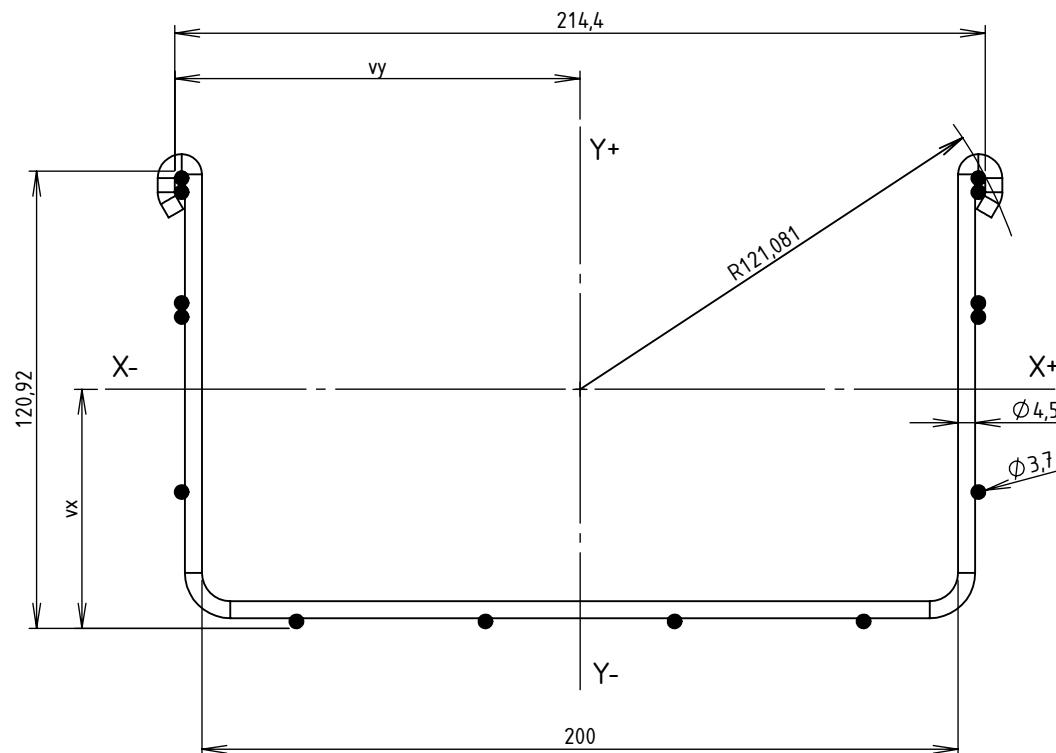

Matière: FIL Ø3.7 INOX 304L - NF EN 10088
 FIL Ø4.5 INOX 304L - NF EN 10088



Usine de Liernais
 BP 1
 21430 LIERNAIS
 TEL.: 03.80.90.51.00
 FAX: 03.80.84.43.66

DESIGNATION:

CC 200 BFR110 INOX 304L
 INERTIE

Propriété GEWISS France - Toute reproduction et utilisation tierce requièrent l'accord écrit de GEWISS France

DESSINE PAR:	BERGEROT D.	VERIFIE PAR:	LEGUY C.	FORMAT A4 H
DATE:	17/07/2020	ECHELLE:	1:2	
N°:	MV50643_07			

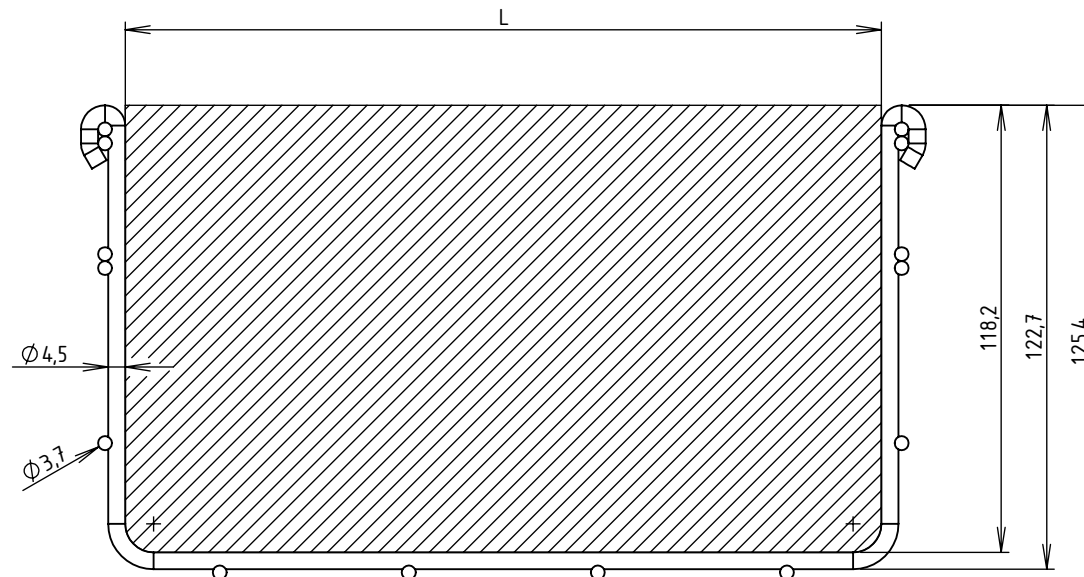

CODE	L (mm)	SECTION UTILE (mm ²)	CONTENANCE (Kg/m)	
			Communication (d = 0.15 Kg/cm ² /m)	Puissance (d = 0.25 Kg/cm ² /m)
MV50X43	200	23619	35.43	59.05



Usine de Liernais
BP 1
21430 LIERNAIS
TEL.: 03.80.90.51.00
FAX: 03.80.84.43.66

DESIGNATION:

SECTIONS UTILES ET CONTENANCES BFR110
200 BFR110

Propriété GEWISS France - Toute reproduction et utilisation tierce requièrent l'accord écrit de GEWISS France

DESSINE PAR:	BERGEROT D.	VERIFIE PAR:	LEGUY C.	FORMAT A4 H
DATE:	05/06/2024	ECHELLE:	1:2	
N°:	MV50X43			