

Matière: FIL Ø4.5 INOX 304L - NF EN 10088  
 FIL Ø4.9 INOX 304L - NF EN 10088  
 CPS: Charge pratique de sécurité - NF EN 61537

CODE	L (mm)	POIDS NET (Kg)	COLISAGE (m)	CPS portée 1.5m/2m/2.5m (daN/m)
MV50645	300	8.678	6	111.5 / 81 / 59.8
MV50646	400	9.895	6	127.5 / 97.9 / 71.2



Usine de Liernais  
 BP 1  
 21430 LIERNAIS  
 TEL.: 03.80.90.51.00  
 FAX: 03.80.84.43.66

DESIGNATION:

CC 300/400 BFR110 INOX 304L

Propriété GEWISS France - Toute reproduction et utilisation tierce requièrent l'accord écrit de GEWISS France

DESSINE PAR:	BERGEROT D.	VERIFIE PAR:	LEGUY C.	FORMAT A4 H
DATE:	17/07/2020	ECHELLE:	1:6	
N°:	MV50645 et MV50646_05			

CODE	REF.	L (mm)	L1 (mm)	POIDS NET (Kg)	POIDS NET (Kg/m)	vx (mm)	vy (mm)	S (mm <sup>2</sup> )	Ixx (mm <sup>4</sup> )	Iyy (mm <sup>4</sup> )	Ixx/vx (mm <sup>3</sup> )	Iyy/vy (mm <sup>3</sup> )	RAYON DE GIRATION R (mm)
MV50645	300 BFR30	300	316.8	8.678	2.893	66.051	158.4	254.469	541371.13	4367888.105	8196.26	27575.05	170.931
MV50646	400 BFR30	400	416.8	9.895	3.298	71.885	208.4	286.278	615831.922	8049374.831	8566.9	38624.64	219.843

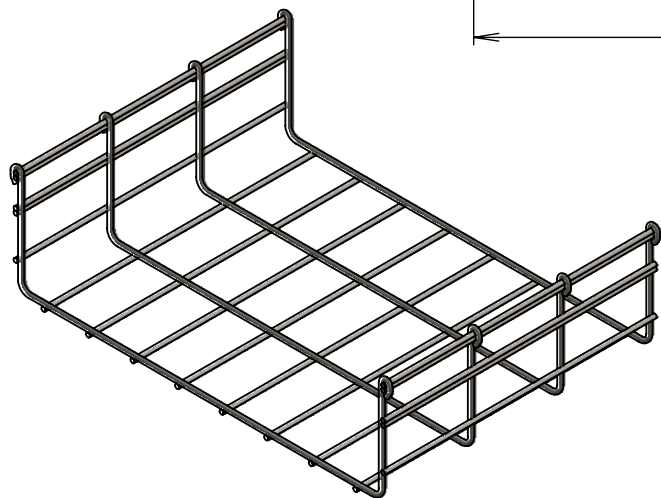
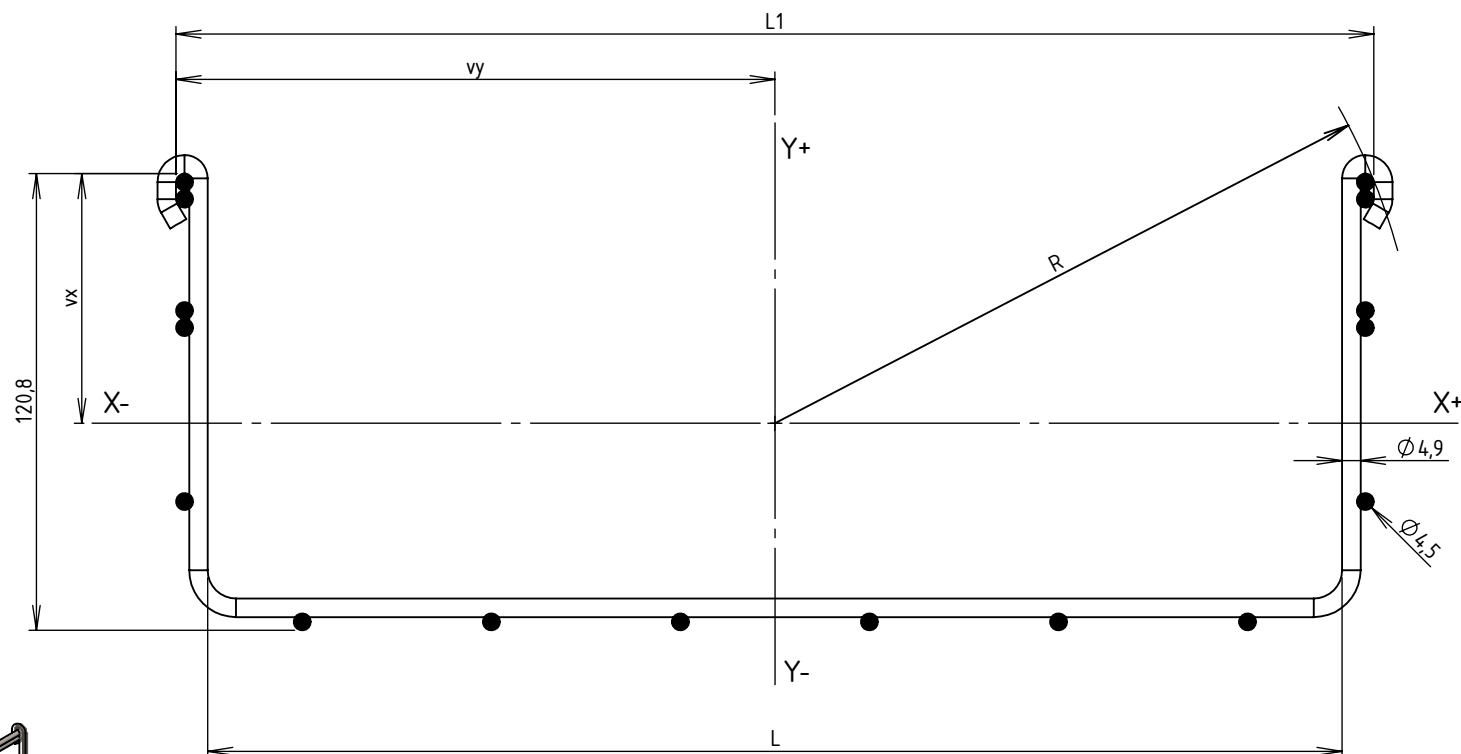

Matière: FIL Ø4.5 INOX 304L - NF EN 10088  
 FIL Ø4.9 INOX 304L - NF EN 10088



Usine de Liernais  
 BP 1  
 21430 LIERNAIS  
 TEL.: 03.80.90.51.00  
 FAX: 03.80.84.43.66

DESIGNATION:

CC 300/400 BFR110 INOX 304L  
 INERTIES

Propriété GEWISS France - Toute reproduction et utilisation tierce requièrent l'accord écrit de GEWISS France

DESSINE PAR:	BERGEROT D.	VERIFIE PAR:	LEGUY C.	FORMAT A4 H
DATE:	17/07/2020	ECHELLE:	1:2	
N°:	MV50645 et MV50646_05			

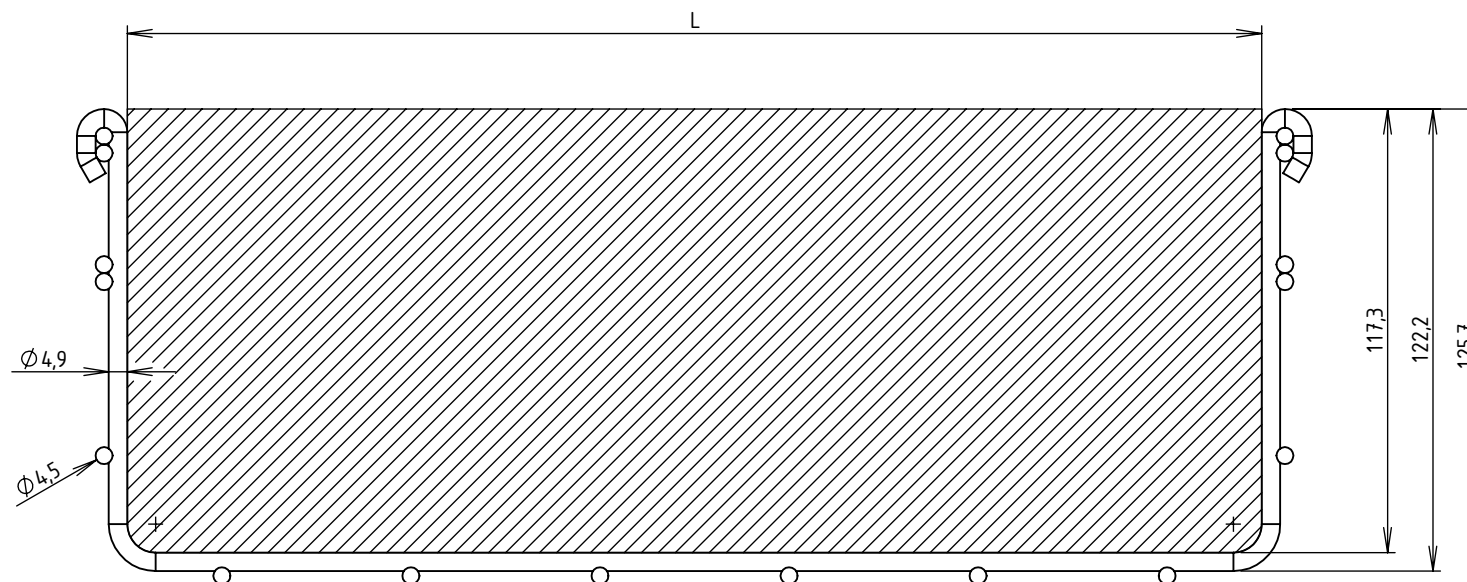

CODE	L (mm)	SECTION UTILE (mm <sup>2</sup> )	CONTENANCE (Kg/m)	
			Communication (d = 0.15 Kg/cm <sup>2</sup> /m)	Puissance (d = 0.25 Kg/cm <sup>2</sup> /m)
MV50X45	300	35167	52.75	87.92
MV50X46	400	46897	70.35	117.24



Usine de Liernais  
BP 1  
21430 LIERNAIS  
TEL.: 03.80.90.51.00  
FAX: 03.80.84.43.66

DESIGNATION:

SECTIONS UTILES ET CONTENANCES BFR110  
300/400 BFR110

Propriété GEWISS France - Toute reproduction et utilisation tierce requièrent l'accord écrit de GEWISS France

DESSINE PAR:	BERGEROT D.	VERIFIE PAR:	LEGUY C.	FORMAT A4 H
DATE:	05/06/2024	ECHELLE:	1:2	
N°:	MV50X45 à MV50X46			