

DÉTAIL A
ECHELLE 1 : 4

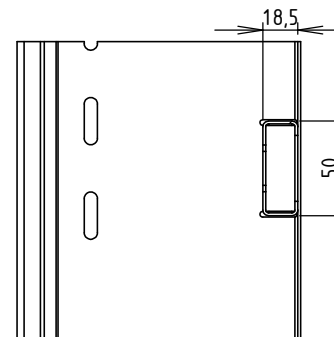

COUPE C-C
ECHELLE 1 : 4

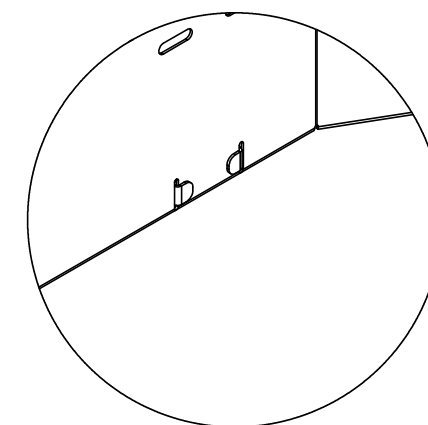

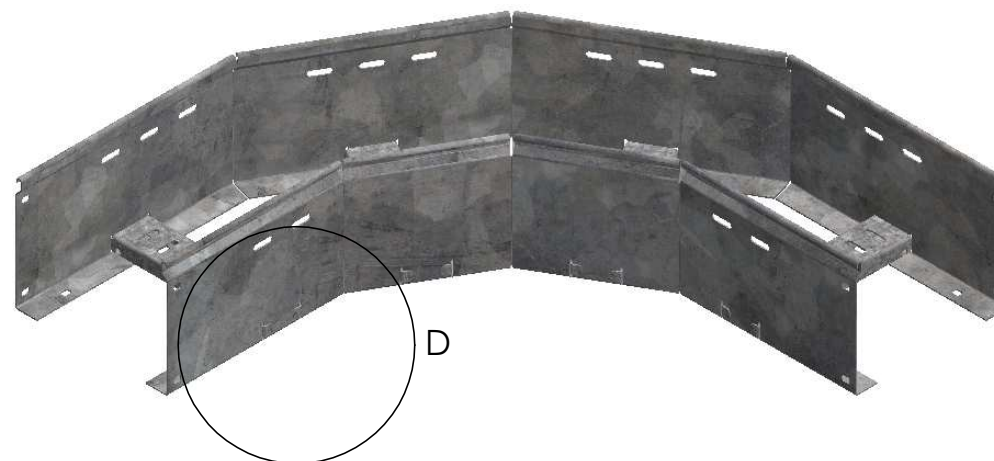
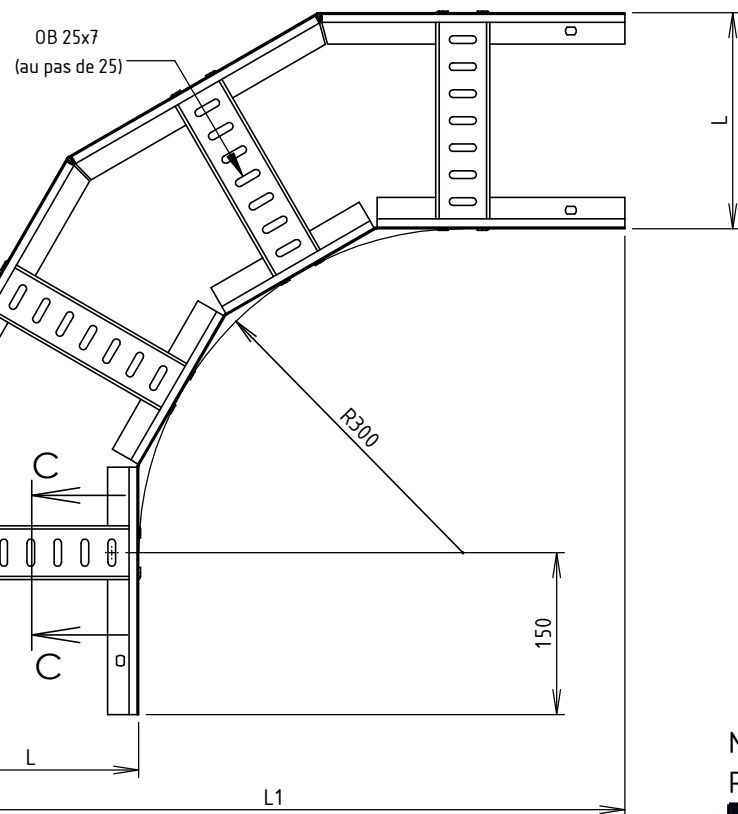

DÉTAIL D
ECHELLE 1 : 4



Matière: TÔLE GALVA 1.50 DX51D + Z275
Revêtement: Z275 - NF EN 10346

CODE	L (mm)	L1 (mm)	Poids (kg)
MV92131	100	550	4.16
MV92132	200	650	4.82
MV92133	300	750	5.59
MV92134	400	850	6.47
MV92135	500	950	7.14
MV92136	600	1050	7.87

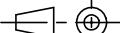
  Usine de Liernais BP 1 21430 LIERNAIS TEL.: 03.80.90.51.00 FAX: 03.80.84.43.66	DESIGNATION:		COUDE 90° EAC ML 150 Z275	
	DESSINE PAR:	BONIN G.	VERIFIE PAR:	BERGEROT D.
	DATE:	22/10/2015	ECHELLE:	1:7
	N°:	MV92131 à MV92136		

FORMAT
A4 H