

Matière: FIL Ø3.7 INOX 304L - NF EN 10088
 CPS: Charge pratique de sécurité - NF EN 61537

CODE	L (mm)	POIDS NET (Kg)	COLISAGE (m)	CPS portée 1.5/2.0/2.5m (daN/m)
MV50622	150	2.465	18	11/7.5/5
MV50623	200	2.843	12	15/10/7.5



Usine de Liernais
 BP 1
 21430 LIERNAIS
 TEL.: 03.80.90.51.00
 FAX: 03.80.84.43.66

DESIGNATION:

CC 150/200 BFR30 INOX 304L

Propriété GEWISS France - Toute reproduction et utilisation tierce requièrent l'accord écrit de GEWISS France

DESSINE PAR:	BERGEROT D.	VERIFIE PAR:	LEGUY C.	FORMAT A4 H
DATE:	09/07/2020	ECHELLE:	1:4	
N°:	MV50622 et MV50623_05			

CODE	REF.	L (mm)	L1 (mm)	POIDS NET (Kg)	POIDS NET (Kg/m)	vx (mm)	vy (mm)	S (mm ²)	Ixx (mm ⁴)	Iyy (mm ⁴)	Ixx/vx (mm ³)	Iyy/vy (mm ³)	RAYON DE GIRATION R (mm)
MV50622	150 BFR30	150	162.8	2.465	0.822	20.696	81.4	75.265	19344.041	311295.526	934.67	3824.27	82.99
MV50623	200 BFR30	200	212.8	2.843	0.948	20.19	106.4	86.017	22543.222	577334.844	1116.55	5426.08	107.996

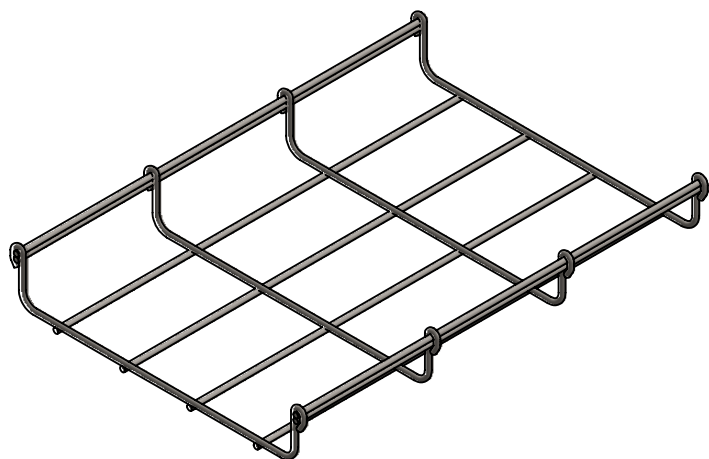
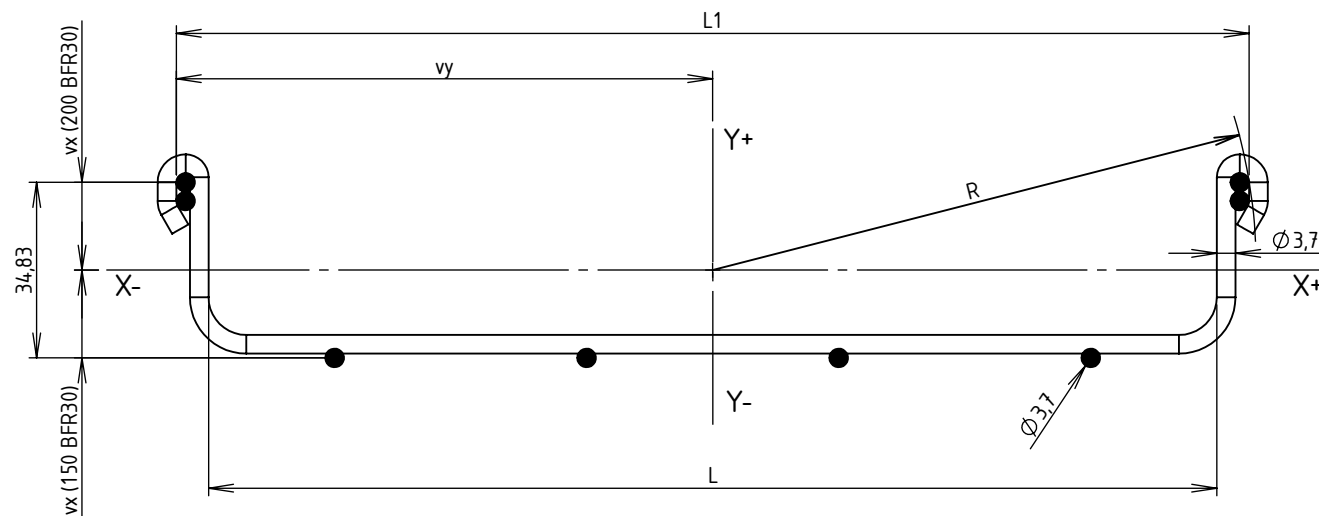

Matière: FIL Ø3.7 INOX 304L - NF EN 10088



Usine de Liernais
BP 1
21430 LIERNAIS
TEL.: 03.80.90.51.00
FAX: 03.80.84.43.66

DESIGNATION:

CC 150/200 BFR30 INOX 304L
INERTIES

Propriété GEWISS France - Toute reproduction et utilisation tierce requièrent l'accord écrit de GEWISS France

DESSINE PAR:	BERGEROT D.	VERIFIE PAR:	LEGUY C.	FORMAT A4 H
DATE:	09/07/2020	ECHELLE:	1:1.5	
N°:	MV50622 et MV50623_05			

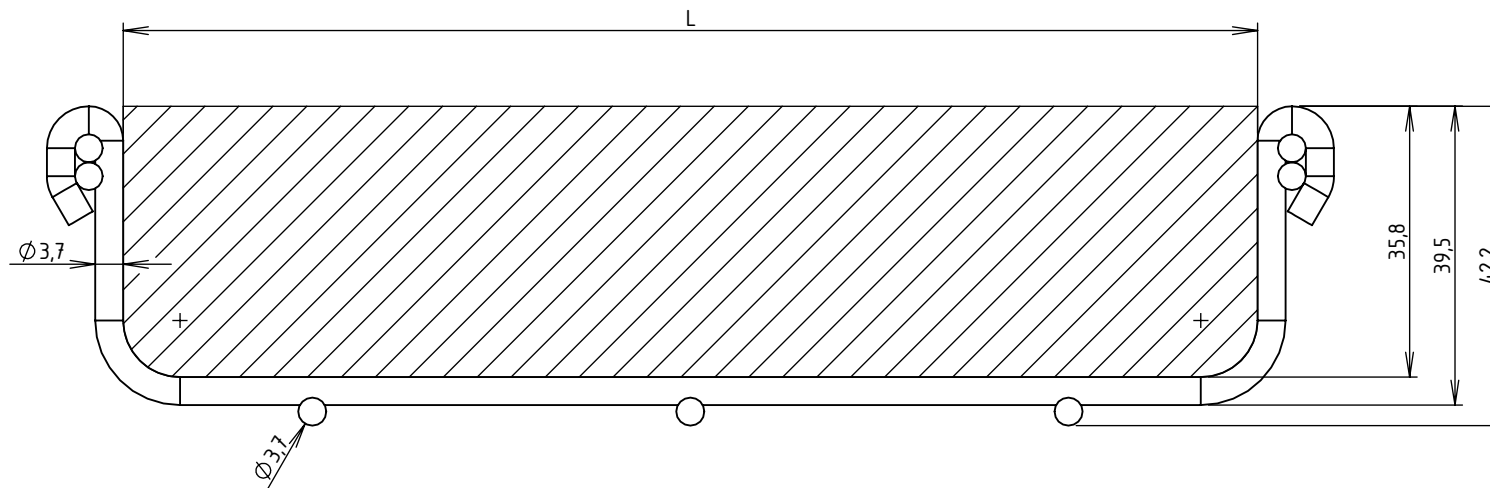

CODE	L (mm)	SECTION UTILE (mm ²)	CONTENANCE (Kg/m)	
			Communication (d = 0.15 Kg/cm ² /m)	Puissance (d = 0.25 Kg/cm ² /m)
MV50X22	150	5350	8.03	13.38
MV50X23	200	7142	10.71	17.86



Usine de Liernais
BP 1
21430 LIERNAIS
TEL.: 03.80.90.51.00
FAX: 03.80.84.43.66

DESIGNATION:

SECTIONS UTILES ET CONTENANCES BFR30
CC 150/200 BFR30

Propriété GEWISS France - Toute reproduction et utilisation tierce requièrent l'accord écrit de GEWISS France

DESSINE PAR:	BERGEROT D.	VERIFIE PAR:	LEGUY C.	FORMAT A4 H
DATE:	05/06/2024	ECHELLE:	1:1	
N°:	MV50X22 à MV50X23			