

FICHE TECHNIQUE

CODE	L (mm)	POIDS NET (Kg)	COLISAGE (NR)
MV65890	200	0.316	50
MV65895	400	0.632	24
MV65891	500	0.790	24
MV65892	1000	1.580	6
MV65893	2000	3.159	6
MV65894	3000	4.739	4

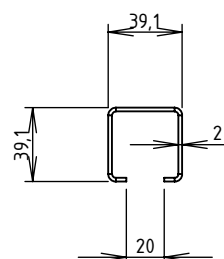

Matière: FEUILLE 2.00 INOX 316L - NF EN 10088-2/ISO9445

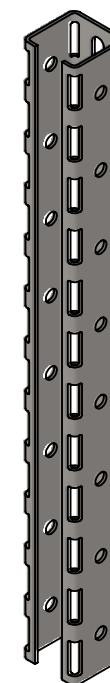
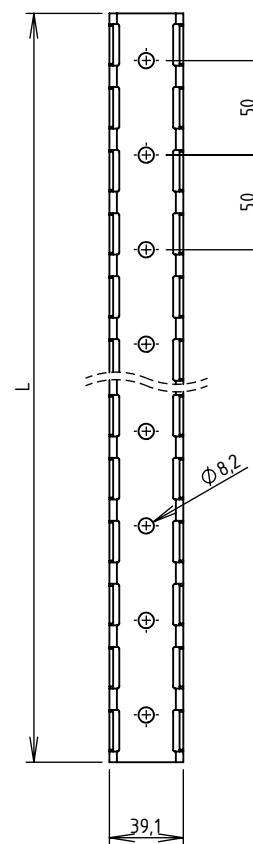
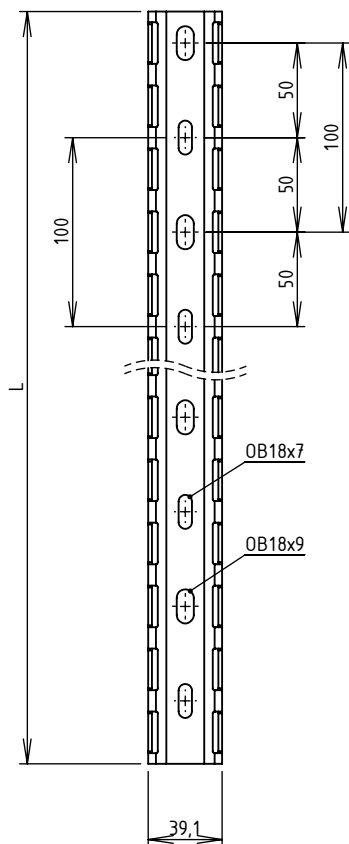

DESIGNATION:

RAIL C40 PLURIEL INOX316L

Propriété GEWISS France - Toute reproduction et utilisation tierce requièrent l'accord écrit de GEWISS France

Usine de Liernais
BP 1
21430 LIERNAIS
TEL.: 03.80.90.51.00
FAX: 03.80.84.43.66

DESSINE PAR:	BERGEROT D.	VERIFIE PAR:	LEGUY C.	FORMAT A4 H
DATE:	25/05/2023	ECHELLE:	1:4	
N°:	MV65890 à MV65895_01			