

FICHE TECHNIQUE

Mise en situation: INCLINE

Positionnement des boulons dans les lumières R3.5 de l'équerre de pendard

MONTAGE DOUBLE
COUPLE MAXI
ADMISSIBLE x2:
11 daN.m

MONTAGE SIMPLE
COUPLE MAXI
ADMISSIBLE:
5.5 daN.m

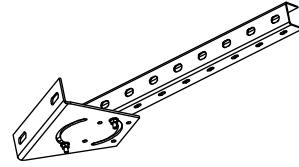
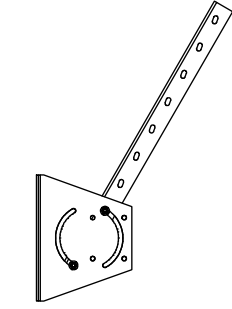
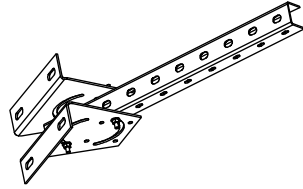

Mise en situation: DROIT

Positionnement des boulons dans les perfos Ø7 de l'équerre de pendard

MONTAGE DOUBLE
COUPLE MAXI
ADMISSIBLE x2:
47 daN.m

MONTAGE SIMPLE
COUPLE MAXI
ADMISSIBLE:
23.5 daN.m

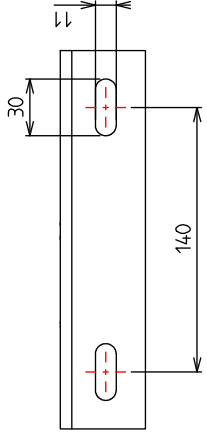
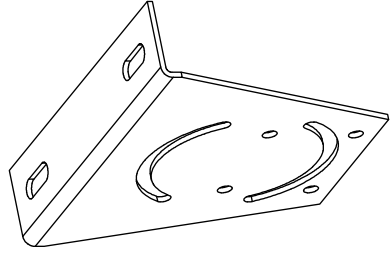
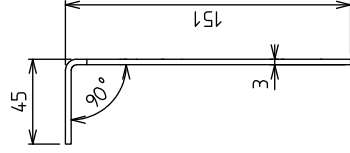
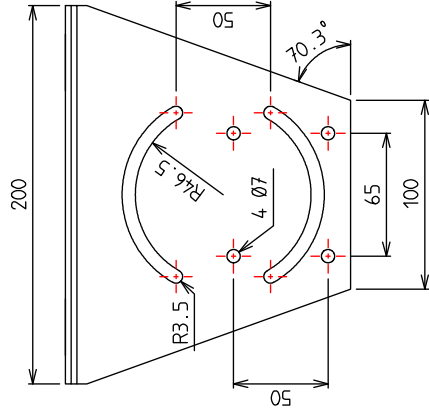
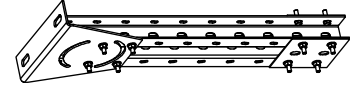
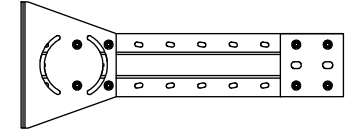
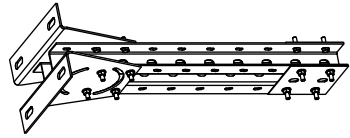

Poids net: 0.680 Kg
Colisage par 20 pièces
Matière: TÔLE 3.00 INOX 304L

	DESIGNATION: EQUERRE DE PENDARD EDF40 INOX 304L		
	Dessine par: BERGEROT d.	Vérifié par: LEGUY c.	Format: A4
Usine de Liernais BP 1 21430 LIERNAIS TEL: 03.80.90.51.00 FAX: 03.80.84.43.66	Date: 13/07/2011	Echelle: 1/4	N°: MV64611_02