

Colisage: 12 m
 Poids net: 3.566 Kg
 Matière: FIL Ø3.7 INOX 316L - NF EN 10088
 CPS: Charge pratique de sécurité - NF EN 61537
 32 daN/m : portée 1.5m
 25 daN/m : portée 2.0m
 16 daN/m : portée 2.5m



Usine de Liernais
 BP 1
 21430 LIERNAIS
 TEL.: 03.80.90.51.00
 FAX: 03.80.84.43.66

DESIGNATION:

CC 200 BFR60 INOX 316L

Propriété GEWISS France - Toute reproduction et utilisation tierce requièrent l'accord écrit de GEWISS France

DESSINE PAR:	BERGEROT D.	VERIFIE PAR:	LEGUY C.	FORMAT A4 H
DATE:	08/07/2020	ECHELLE:	1:4	
N°:	MV50833_06			

CODE	REF.	POIDS NET (Kg)	POIDS NET (Kg/m)	vx (mm)	vy (mm)	S (mm ²)	Ixx (mm ⁴)	Iyy (mm ⁴)	Ixx/vx (mm ³)	Iyy/vy (mm ³)	RAYON DE GIRATION R (mm)
MV50833	200 BFR60	3.566	1.189	35.782	106.4	107.521	87284.711	801813.606	2439.35	7535.84	111.769

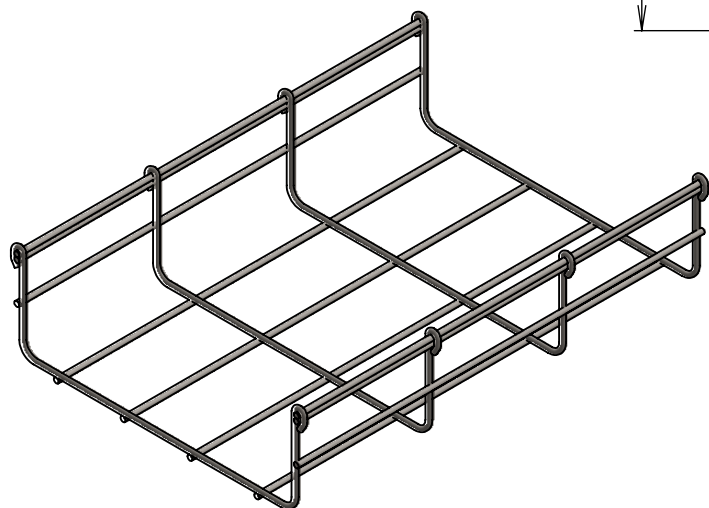
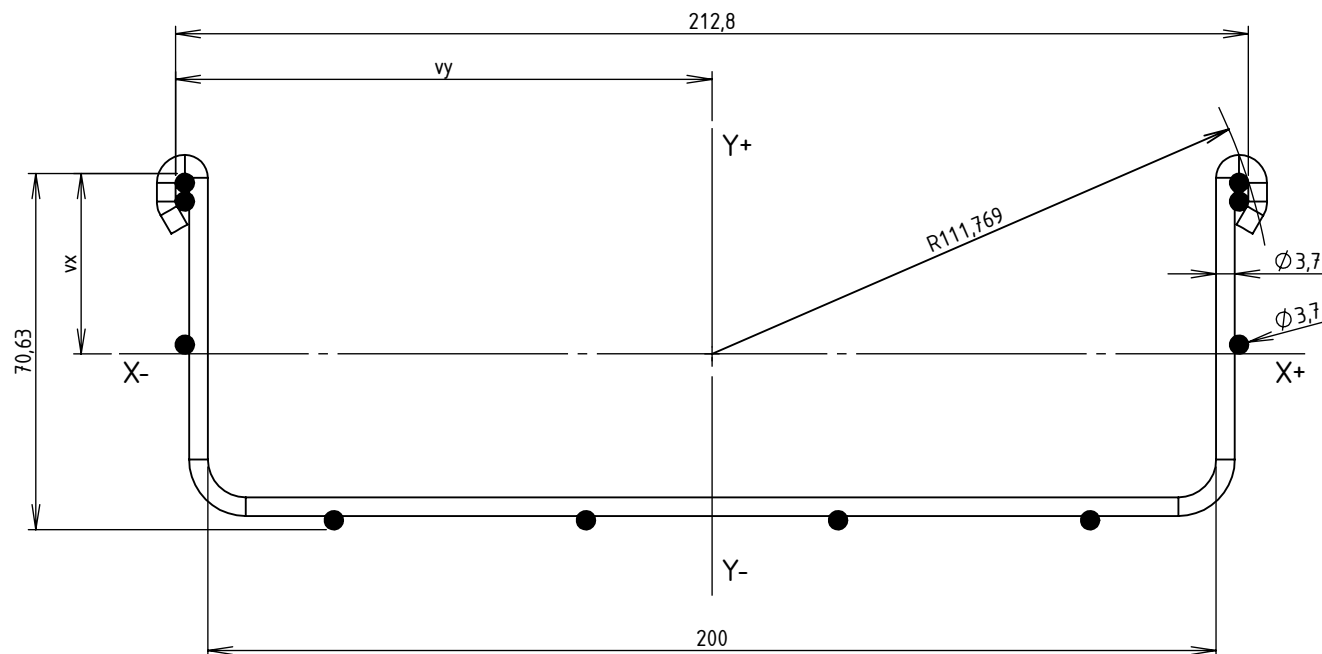

Matière: FIL Ø3.7 INOX 316L - NF EN 10088



Usine de Liernais
BP 1
21430 LIERNAIS
TEL.: 03.80.90.51.00
FAX: 03.80.84.43.66

DESIGNATION:

CC 200 BFR60 INOX 316L
INERTIE

Propriété GEWISS France - Toute reproduction et utilisation tierce requièrent l'accord écrit de GEWISS France

DESSINE PAR:	BERGEROT D.	VERIFIE PAR:	LEGUY C.	FORMAT A4 H
DATE:	08/07/2020	ECHELLE:	1:1.5	
N°:	MV50833_06			

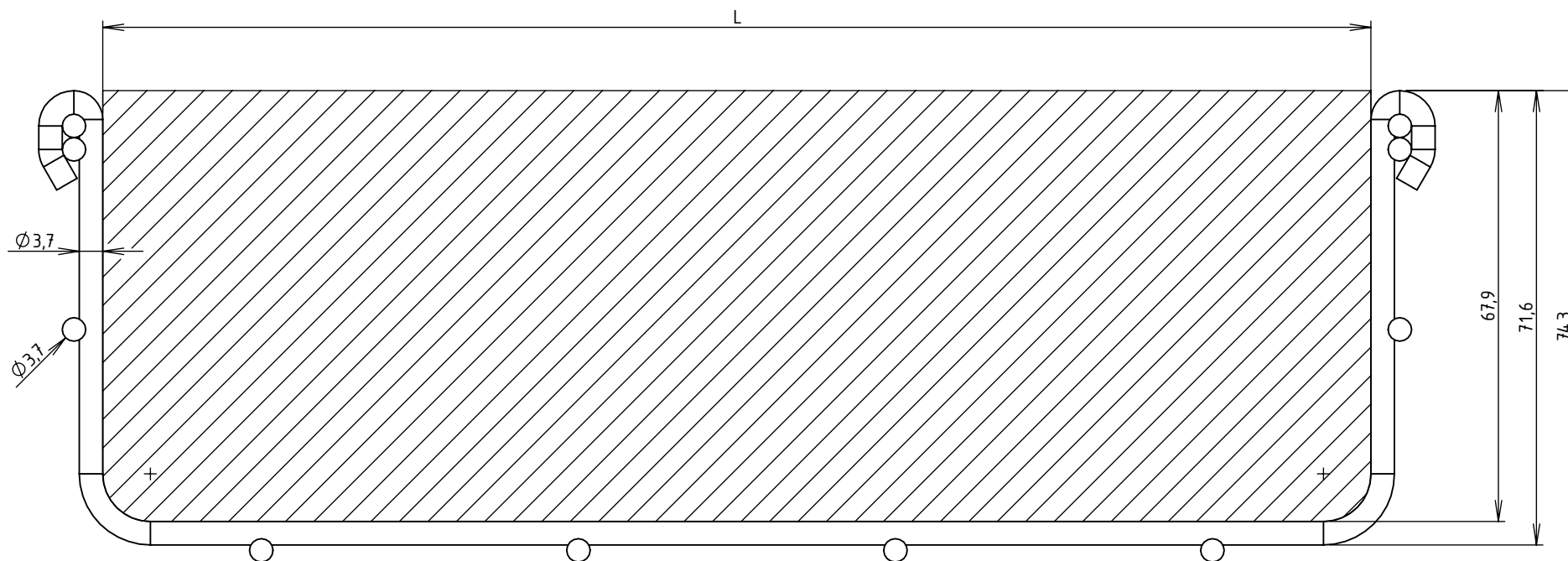

CODE	L (mm)	SECTION UTILE (mm ²)	CONTENANCE (Kg/m)	
			Communication (d = 0.15 Kg/cm ² /m)	Puissance (d = 0.25 Kg/cm ² /m)
MV50X33	200	13562	20.34	33.91



Usine de Liernais
BP 1
21430 LIERNAIS
TEL.: 03.80.90.51.00
FAX: 03.80.84.43.66

DESIGNATION:
SECTIONS UTILES ET CONTENANCES BFR60
200 BFR60

Propriété GEWISS France - Toute reproduction et utilisation tierce requièrent l'accord écrit de GEWISS France

DESSINE PAR:	BERGEROT D.	VERIFIE PAR:	LEGUY C.	FORMAT A4 H
DATE:	05/06/2024	ECHELLE:	1:1	
N°:	MV50X33			