



Poids net: 0.380 Kg
 Surface: 98805 mm²
 Matière cornière: BANDE REFENDUE 1.00 DX51D + Z275 - NF EN 10143/10346
 Matière fond: FEUILLE 0.90 DX51D + Z275 - NF EN 10143/10346
 Revêtement : Z275 - NF EN 10346

 	DESIGNATION:			ECLISSE D'ANGLE A BOUL 90° BRN50 Z275	
	Propriété GEWISS France - Toute reproduction et utilisation tierce requièrent l'accord écrit de GEWISS France				
Usine de Liernais BP 1 21430 LIERNAIS TEL.: 03.80.90.51.00 FAX: 03.80.84.43.66	DESSINE PAR:	DOS SANTOS A.	VERIFIE PAR:	LEGUY C.	FORMAT A4 H
	DATE:	14/10/2020	ECHELLE:	1:4	
	N°:	MVN3510GA			

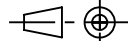
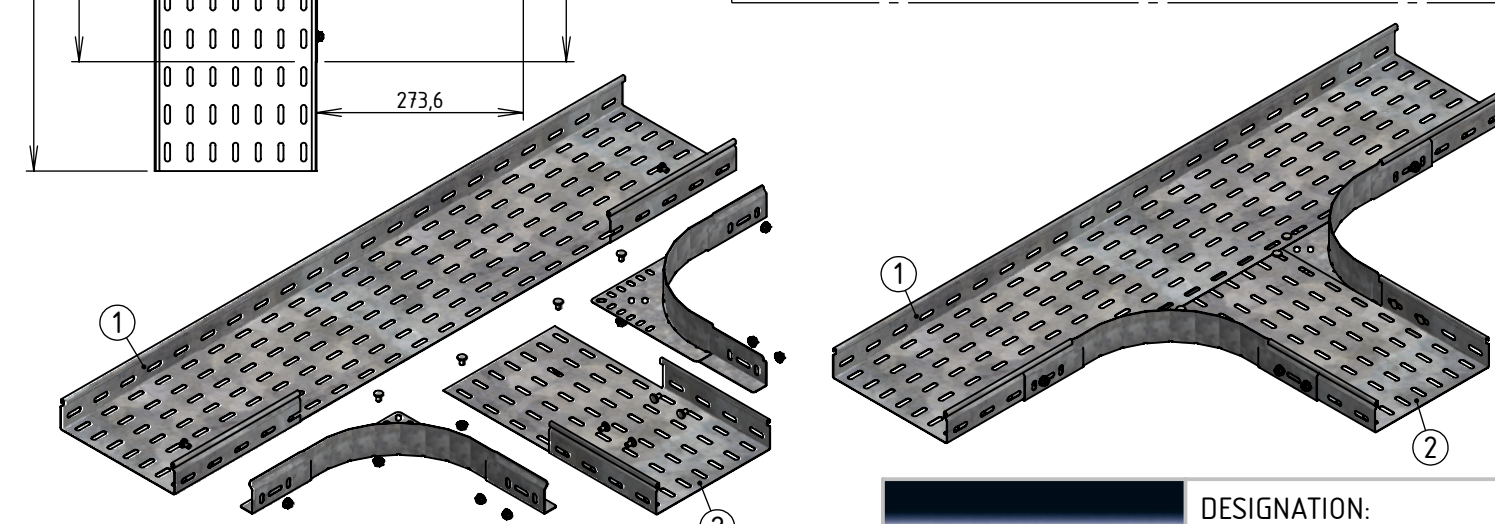
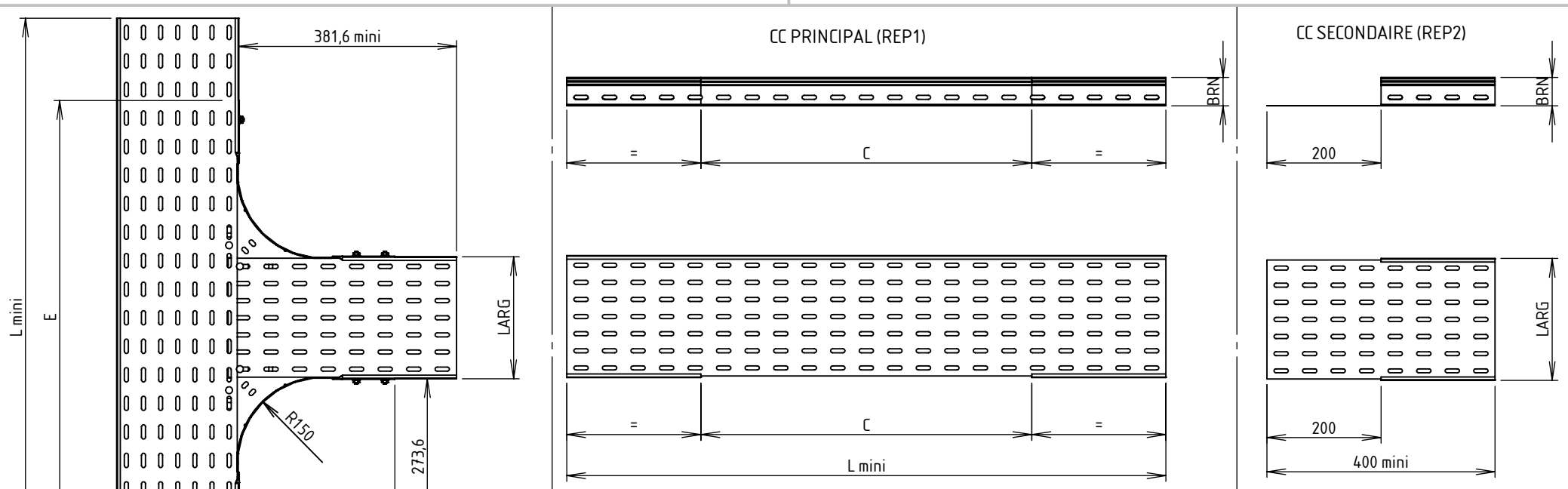

LARG cc secondaire (mm)	L mini cc principal (mm)	C (mm)	E encombrement cc secondaire + éclipse (mm)
65	900	430	611
95	950	460	641
155	1000	520	701
215	1050	580	761
305	1150	670	851
395	1250	760	941
515	1350	880	1061
605	1450	970	1151

Assemblage réalisé par boulons à tête ergot (MV66X00)

BRN	REF	NB BOULONS
35/50	65/215/515	10
	95/125/305/395/605	12
80/95	65/215/515	16
	95/125/305/395/605	20



Usine de Liernais
BP 1
21430 LIERNAIS
TEL.: 03.80.90.51.00
FAX: 03.80.84.43.66

DESIGNATION:
MODE OPERATOIRE DE REALISATION DE SORTIE LATÉRALE
AVEC ECLISSE D'ANGLE BRN35-50-80-95

Propriété GEWISS France - Toute reproduction et utilisation tierce requièrent l'accord écrit de GEWISS France

DESSINE PAR: BERGEROT D.	VERIFIE PAR: LEGUY C.	FORMAT A4 H
DATE: 29/08/2023	ECHELLE: 1:10	

N°: MVN3510EA-GA-LA-NA et MVN3520EA-GA-LA-NA et MVN3570EA-GA-LA-NA_SORTIE LAT

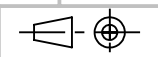

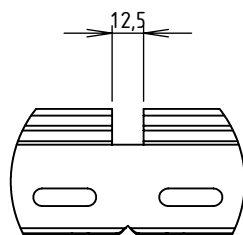
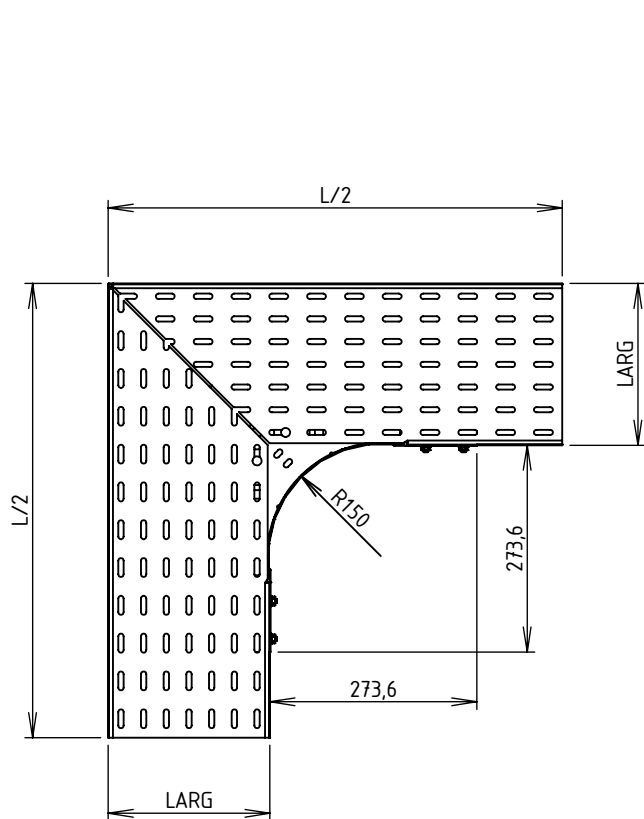

DÉTAIL A
ECHELLE 1 : 3

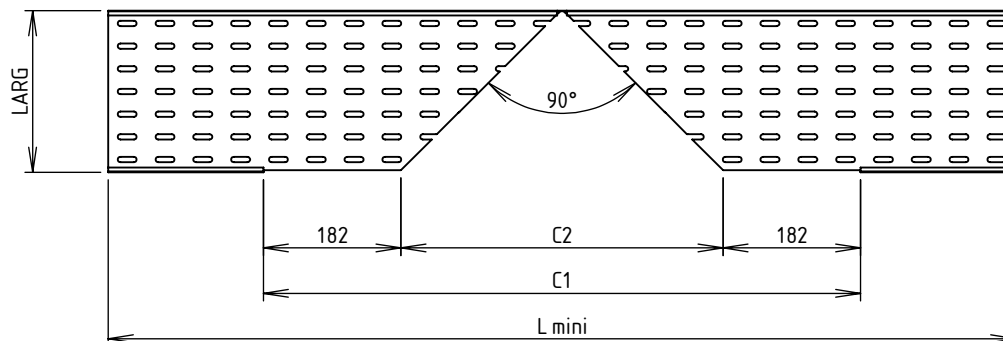
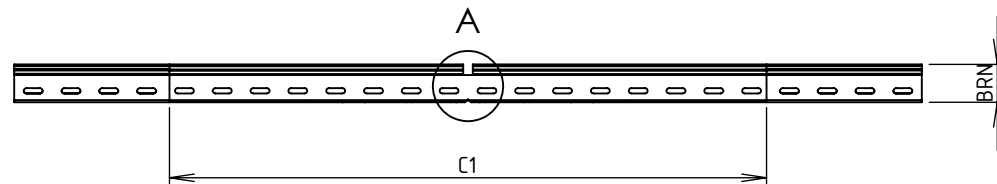

LARG (mm)	L mini (mm)	C1 (mm)	C2 (mm)
65	900	490	126
95	950	550	186
155	1050	670	306
215	1200	790	426
305	1350	970	606
395	1550	1150	786
515	1800	1390	1026
605	1950	1570	1206

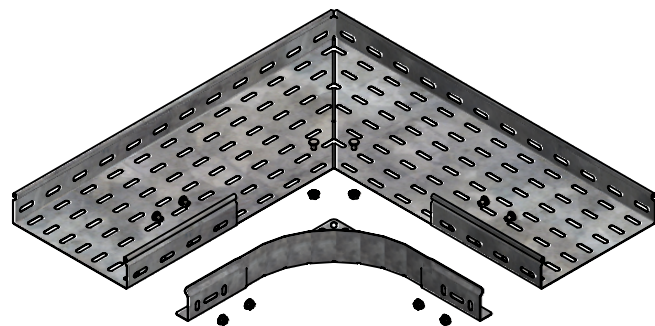
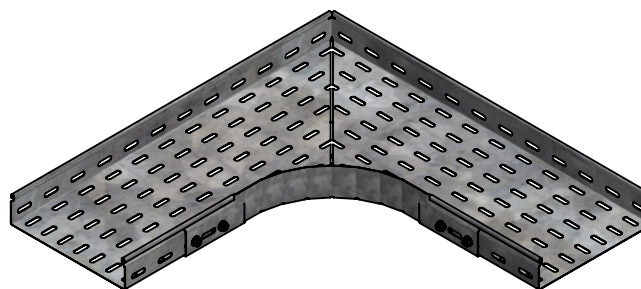

Assemblage réalisé par boulons à tête ergot (MV66X00)
 - 6 boulons en BRN35 et BRN50
 - 10 boulons en BRN80 et BRN95



Usine de Liernais
 BP 1
 21430 LIERNAIS
 TEL.: 03.80.90.51.00
 FAX: 03.80.84.43.66

DESIGNATION:

MODE OPERATOIRE DE REALISATION DE COUDE 90°
 AVEC ECLISSE D'ANGLE BRN35-50-80-95

Propriété GEWISS France - Toute reproduction et utilisation tierce requièrent l'accord écrit de GEWISS France

DESSINE PAR:	BERGEROT D.	VERIFIE PAR:	LEGUY C.	FORMAT A4 H
DATE:	29/08/2023	ECHELLE:	1:10	

N°: MVN3510EA-GA-LA-NA et MVN3520EA-GA-LA-NA et MVN3570EA-GA-LA-NA_COUDE 90°

